

CABLE TRAY SOLUTIONS

FOR TUNNELS

GUIDE



THE GLOBAL SPECIALIST IN ELECTRICAL AND DIGITAL
BUILDING INFRASTRUCTURES

 **legrand**[®]

CABLE ROUTING SOLUTIONS FOR TUNNELS

The Legrand Group, the global specialist in electrical and digital building infrastructures, can provide solutions to meet the most stringent requirements of the IEC 61537 international standard with its ranges of stainless steel and GRP (fibre glass reinforced polyester) cable trays. These solutions provide optimum safety, flexibility and excellent corrosion resistance for installations in road and rail tunnels.

In addition to performing the cable routing function, this comprehensive range also enables numerous additional solutions specific to underground infrastructures to be incorporated: general and safety lighting, signs, ventilation, etc. With Legrand at your side, you are choosing safety, high quality, expertise and a variety of solutions to ensure that your large-scale projects are simple and problem-free.



Introduction **2**



Cablofil **6**

A specialist team at your side

Legrand works with you on your large-scale projects. Our specialist engineers and our major projects manager can advise you on the various ranges, their use, etc. They will help you design specific solutions tailored to your issues and provide you with relevant answers for the most complex scenarios.

Proximity, responsiveness and competitiveness

As the global specialist in electrical and digital building infrastructures, Legrand offers a complete range of systems worldwide (170,000 catalogue items and 4800 patents) for building electrical installations and information networks suitable for your underground infrastructures. Proximity, responsiveness and competitiveness, all Legrand's expertise is available for you.

You can have total confidence in this internationally recognised Group.

Committed to a sustainable development policy

Legrand, together with its customers and partners, has been committed to a process of continuous improvement for many years, to ensure the long-term and responsible growth of its businesses. The Group thus intends to meet the environmental, economic and social challenges of today and the future.



P31 10



Swifts 14



Polysis 16



TUNNELS: ESSENTIAL REQUIREMENTS

Road and rail tunnels both involve risks of accidents associated with their configurations: geometry of the structure, behaviour of the users travelling through them, and whether or not there are dangerous goods inside the infrastructure. These underground infrastructures therefore have specific sets of requirements, the main ones being the safety of people and property and continuity of service.

Safety of people and property

The characteristics of the components in a tunnel* must meet several objectives if there is a fire:

- Safety of users who are in the tunnel during the evacuation phases
- Safety of the emergency services present in the tunnel
- Safety of users and emergency services who are in locations supported by the structure but who cannot be evacuated quickly
- Limitation of damage and repair costs, and the period during which the structure is closed after a fire.

* Sources: CETU (French tunnels study centre) guide "Comportement au feu des tunnels routiers" (Fire behaviour of road tunnels)

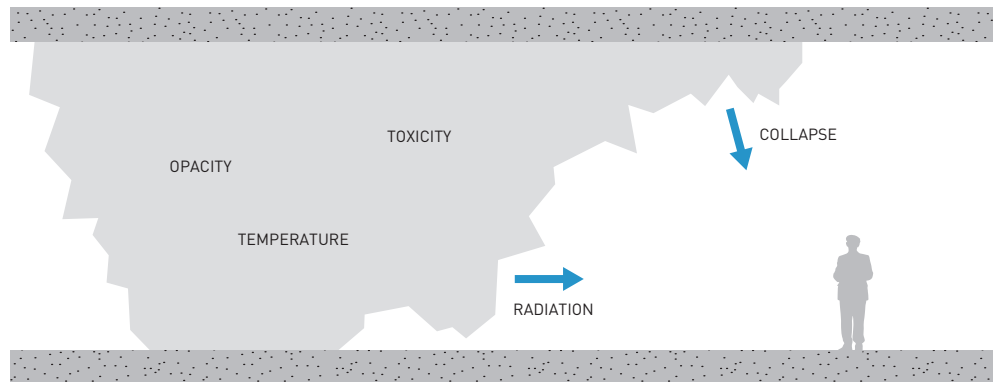

Main risks for users and emergency teams

These objectives lead to requirements concerning various aspects of fire behaviour:

- Fire reaction of a material
- Fire resistance of a structural component (ability to continue performing its function despite the spread of the fire)
- Fire resistance of electromechanical equipment.

If there is a fire, the safety equipment, such as the power supply, lighting and radio communication equipment, must be designed in such a way that it continues to operate for at least one hour, outside the area directly affected by the fire.

Continuity of service

Road and rail tunnels contain large amounts of electrical equipment: safety lighting, ventilation systems, signalling systems, etc. To ensure the safety of users there must be no breaks in the operation of this equipment. It must therefore operate continuously in both normal and accident situations.

Each country has its own regulations on tunnels and a specific structure in terms of distribution networks: tunnels which have very similar characteristics can therefore have very different architectures.

It is however possible to list certain principles which remain the same, including:

- The presence of an emergency power supply (dual supply, generator, etc.)
- The installation of a device to remedy a total power loss. This system (UPS, generator, etc.) must power the essential safety equipment for a limited period.



For more information on fire resistance tests on Legrand cable trays, see: **p. 9 and p. 13**



QUALITY, STRENGTH AND FLEXIBILITY: THREE REQUIREMENTS

In tunnels with complex configurations and for which the regulations are very stringent, it is essential to choose the right products to ensure that the installation operates correctly and that people are safe if there is a problem (fire, accident, etc.). The Legrand range of cable trays offers a comprehensive choice of solutions (welded wire, perforated sheet metal, cable ladder or GRP) to meet the technical and regulatory requirements of these highly critical sites worldwide.

Unfailing quality of materials

Whether you choose 316 L stainless steel or GRP cable trays, the excellent quality of the materials used ensures that installations are highly resistant to corrosion in the polluted, damp or salty environments that are often found in tunnels. Several product families are available in standard or made-to-measure versions.

| | 316L ¹ | 304L ² | GC ³ | GRP ⁴ |
|----------|-------------------|-------------------|-----------------|------------------|
| Cablofil | x | x | x | |
| P31 | x | x | x | |
| Swift | x | | x | |
| Polysis | | | | x |

(1) 316 L or 1.4404 stainless steel (standard EN 10088-2).

(2) 304 L or 1.4307 stainless steel (standard EN 10088-2).

Please consult Legrand for 304 L stainless steel and HDG steel ranges.

(3) Hot-dip galvanised after manufacture (standard EN ISO 1461).

(4) Fibre glass and thermosetting resin (NF P 92-501, NF F 16101, BS 476 Part 1, ASTM E84).

Optimised fixing systems for each range

There are very stringent requirements for cable support systems in rail or road tunnels. Tunnels can have rounded walls or ceilings, concrete beams, downward runs, etc. Whatever the shape and the technical requirements of the tunnel, Cablofil, P31 and Polysis cable trays and Swifts cable ladders have optimised support systems which fit the walls perfectly and provide strength and stability for the installations.



Reliability and high fire resistance

The metal cable tray systems undergo the tests recommended by the various local standards for each country. Standard DIN 4102-12, for example, is known for its rigour. Several configurations from our Cablofil and P31 ranges have been tested and have obtained E 30/E 90 fire resistance certificates. They therefore guarantee that the power supply or signalling cables maintain their functions for 30, 60 or 90 minutes if there is a fire, thus enabling the fire alarm and evacuation, and exit route signalling installations, etc. to continue to operate. GRP cable trays are made of a halogen-free self-extinguishing material which has excellent resistance to fire, smoke and damp (M1 F0).

Mechanical performance

All the products and accessories are tested in accordance with the requirements of the IEC 61537 international standard. They provide outstanding mechanical performance.

Multifunction systems

The Legrand cable tray ranges not only perform their initial function, to support conductors, but their specific accessories enable them to take additional equipment: luminaires, signs, emergency lighting, etc. Their high degree of strength gives them an excellent load capacity.

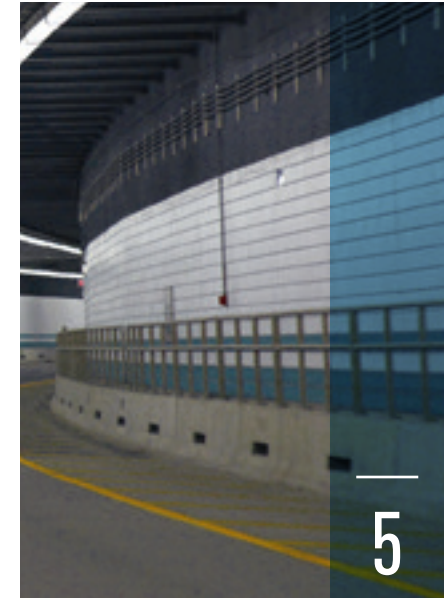

CABLOFIL

CABLOFIL
STEEL WIRE CABLE TRAY

6



CABLOFIL,
FLEXIBILITY FOR
ALL ENVIRONMENTS

The construction of a tunnel is dependent on the geological constraints which affect the route. Whatever the situation (slope, bend, etc.), Cablofil wire cable trays offer excellent flexibility and are suitable for all tunnel configurations, even the most complex. With Cablofil it is very easy to create horizontal and vertical configurations which fit the curvature of the underground infrastructure perfectly, and a significant amount of time is saved when creating junctions (the cable tray is configured on-site).



Quick to install

EDT coupler: fast and reliable coupling.

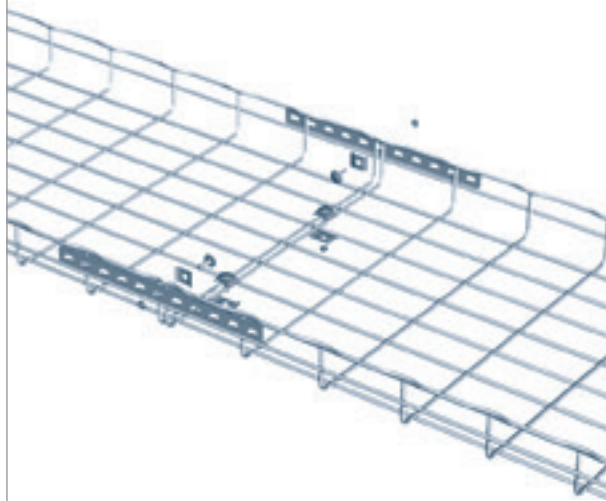
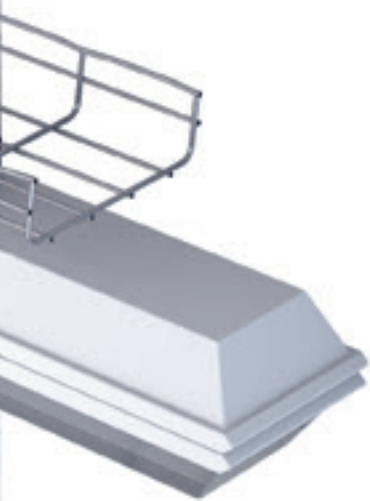

Numerous configurations

Numerous configurations can be created: avoidance of obstacles, 90° bends, curves, junctions, etc.

Safe-T-Edge exclusive safety edge

T-welded so there are no sharp edges, and to avoid accidents during installation.

Strong and durable

- Corrosion-resistant as a result of various surface treatments.
- Designed in welded steel wire with a 2 metre span for efficient, adaptable and economic cable management.
- CTR reinforcement bracket: to increase the span between two supports to 3 metres.

A 90% open structure

- Easy visual inspection and maintenance of cables.
- Minimum temperature rise of cables: excellent ventilation.
- No wind resistance.
- Cost-effective solution as it has a 2 m span.
- Dust retention minimised for quick, efficient cleaning of installations.

CABLOFIL, GUARANTEED FIRE RESISTANCE

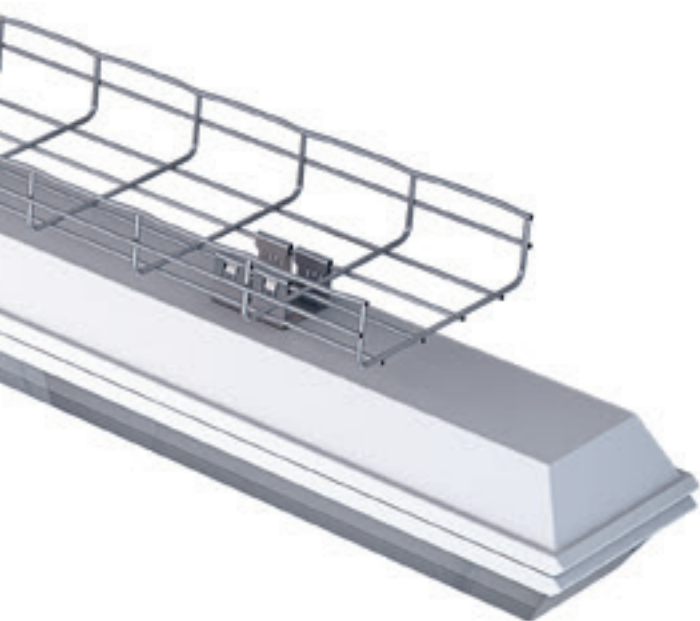

Lorry fires are the most feared events in road tunnels. If they occur, each structural element and each item of equipment must continue to perform its function despite the temperature rise and possible spread of the fire. Cablofil, the Legrand cable tray with the most certifications, has successfully passed all the laboratory tests and complies with the requirements of the standards. It is certified E 30/E 90 and CSIRO.

German standard DIN 4102-12

This standard is currently used as the reference, as there is still no European standard on fire resistance for cable trays installed in tunnels. DIN 4102-12 standard specifies that the complete system comprising cable trays, accessories and cables must be tested in a furnace at least 3 m long, for a period of 30, 60 or 90 minutes up to a temperature of 1000°C.

| TEST DURATION | APPROVAL |
|---------------|----------|
| 30 minutes | E 30 |
| 60 minutes | E 60 |
| 90 minutes | E 90 |

The cable tray with the most certifications



E 30/E 90 certification (standard DIN 4102-12)

Four representative examples of tests carried out on more than 20 configurations.

Medium Duty

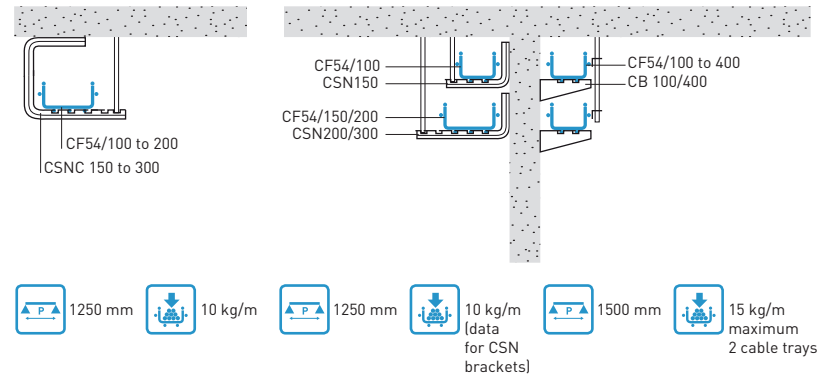

Heavy Duty

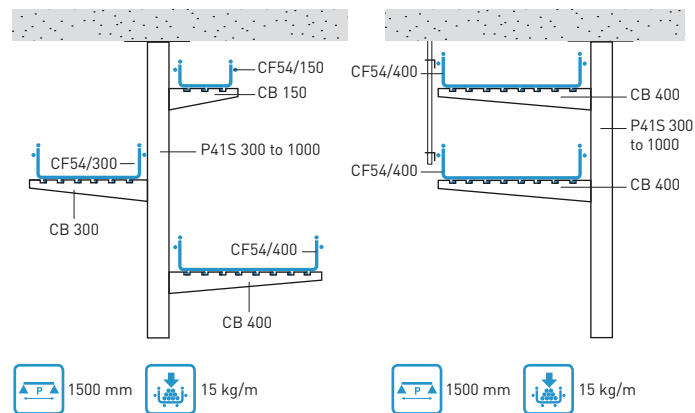

AZ/NSZ 3013: 2005 certification (Australian standard)

Cablofil is approved by the CSIRO organisation for the Australian standard AZ/NSZ 3013: 2005. Here are six configurations that have undergone fire resistance tests.

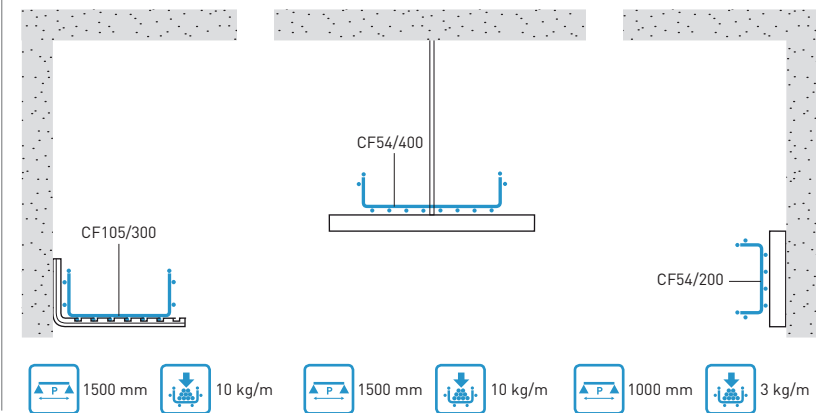
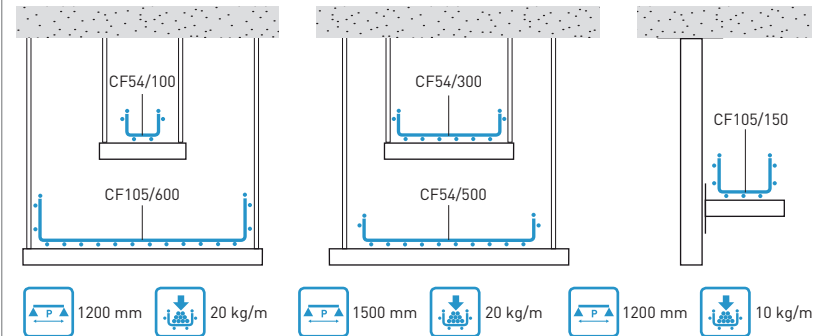

Maintenance of function according to DIN4102-12 standard

Maintenance of function in the event of fire concerns the fire resistance of the electrotechnical installation. The essential parts of the installation which transmit the signals to the emergency lighting, the evacuation installations, the fire alarm systems and other safety installations must continue to transmit these signals for a set time if there is a fire so that people can get out of the tunnel safely.



P31, CLEVER DESIGN
AND HIGH QUALITY

The selection criteria for construction products for a tunnel include quality and installation time. The cleverly-designed, strong P31 range made of perforated sheet metal with safety edges has numerous accessories (for changing direction, fixing, etc.) for easy, lower cost installation. Its excellent mechanical strength makes for very high quality installations.



Easy to install

- **Universal coupler**
Coupler which can be cut or bent without the need for any tool for all bends and risers.
- **Clip-on cover**
The covers can be locked using the CFC clips at either end.



Universal coupler and CFC clip

Ever more possibilities

Ceilings, walls, beams, etc., each tunnel has particular installation requirements, and P31 can provide a response with its range of support systems, including threaded rod suspension, brackets for heavy loads, CA brackets for placing up to four cable trays on top of one another, suspension bracket for ceiling installations.

Cleverly-designed accessories

- **Changes of direction**
90 and 45° bend, cross, tee, etc.
- **Risers**
Convex and concave riser accessories.

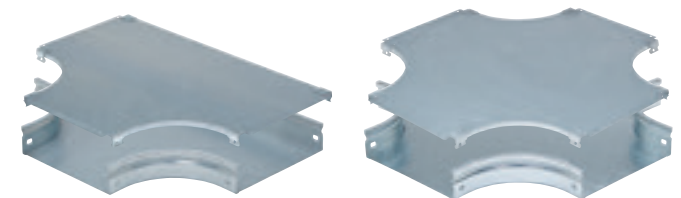

P31, GUARANTEED FIRE RESISTANCE

If there is a fire, the fire reaction and heat resistance of a material are key factors for the safety of people and the behaviour of the tunnel's structure.

In accordance with safety requirements in tunnels, the P31 perforated metal cable tray range guarantees excellent fire resistance. It is E 30 and E 90 approved in line with standard DIN 4102-12.

An optimum flame retardant infrastructure

If there is a fire in a building, it is vital that everyone can get out without any problem. The emergency lighting, emergency exit signs, fire alarm systems and other safety installations must therefore continue to operate for at least 30 to 90 minutes during a fire.



Fire resistance tests

EZ-Path: firestop solution for wall feedthroughs

Controlling the risk of fire in tunnels is vital for saving lives and preventing serious material damage. Preventing fire in the electrical installations is therefore crucial. EZ-Path firestop modules, installed in a wall, stop fire spreading using an expanding foam which reacts spontaneously from 177°C (350°F) or on contact with flames. It obstructs the air flow and confines toxic fumes.



Examples of configurations that have undergone fire resistance tests

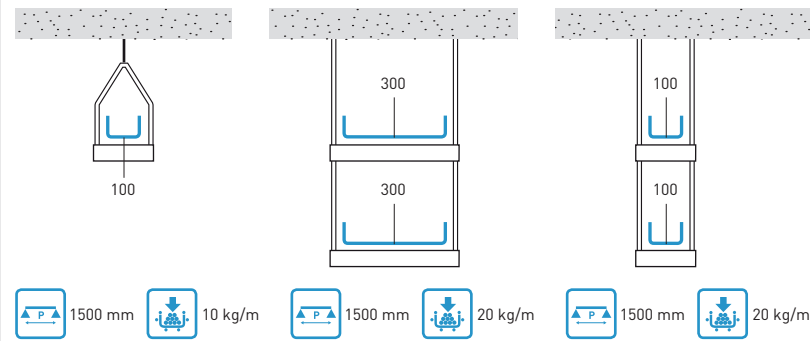

Example illustrated: 316 L stainless steel





SWIFTS, UNFAILING STRENGTH

There can be a great many large diameter cables in a tunnel, representing a significant load for the cable trays, depending on the length of the tunnel and the applications to be supplied. Specially designed for heavy industry and infrastructures, Swifts cable ladders can support very heavy loads using a small number of supports.



Increased capacity for heavy loads

The excellent load capacity of Swifts cable ladders (up to 100 kg/m for a 6 m span) enables them to carry a very large number of cables, making them an ideal solution for large projects. The range is available in widths of up to 900 mm.

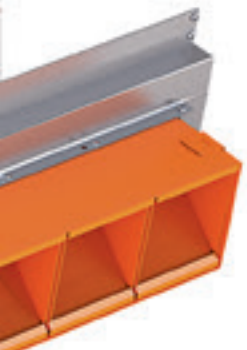

Support system

Hangers and brackets, universal wall brackets, threaded rod suspension, etc. a complete range for strong wall or ceiling-mounted installations. Span between two supports up to 8 m (fewer supports throughout the whole installation).

Numerous configurations

Bendable, flexible or vertical couplers for all site configurations. Sold in pairs with fasteners.

Rolled edge for increased strength and safety

- The sides of the ladders and coupling accessories have a rolled edge to avoid sharp edges and provide additional strength.

Quick to install and lower equipment costs

- All risers have integral couplers.
- Quick fitting bolt-nut joining kit.
- Span between two supports up to 5 m (fewer supports).

Open structure

- Easy visual inspection and maintenance of cables: 300 mm between each crosspiece.
- Minimum temperature rise of cables: maximum ventilation.
- Dust retention minimised
- No water retention if a fire extinguishing system is triggered.



POLYSIS, EXCELLENT
CORROSION
AND FIRE RESISTANCE

Equipment in tunnels is under constant attack from exhaust gases, fumes and damp, salty or chlorinated environments. There is a high risk of corrosion which can in the long term cause damage to equipment which then becomes dangerous for users. The Polysis range, made of GRP, is specially designed for road and rail tunnels and suitable for the harshest environments. It has excellent corrosion and fire resistance and ensures that installations are durable and safe.



Exceptional strength

The Polysis GRP range is made of a pultruded material which combines fibre glass and a thermosetting resin matrix. This manufacturing principle which involves pulling long glass fibre reinforcements (mats, fabrics, rovings) gives the cable trays exceptional mechanical strength, and resistance to corrosion, UV and chemical agents.



Complies with standards: IEC EN 61537, NF P 92-501 and NF F 16101.

Optimum fire resistance

Non-flammable, self-extinguishing material which does not propagate heat. Tested and certified M1 – I0 – F0 according to standards NF P 92-501 & NF F 16-101 and BS 476 part 7.

Excellent mechanical strength

Supports can be up to 3 m apart.

Complies with the RoHS standard

Halogen-free material, compatible with the requirements of the RoHS standard.

Guaranteed safety

Excellent electrical and thermal insulation (operating temperature range: 20 to 130°C). Dimensional stability (very low linear expansion).

Easy, low-cost installation

Accessories can be configured on-site according to the requirements encountered. No earthing.



FOLLOW
US ON

@ legrand.com

 youtube.com/user/legrand

 facebook.com/Legrand

 twitter.com/Legrand

 pinterest.com/legrandgroup

 instagram.com/legrandnews



Head office

and International Department
87045 Limoges Cedex - France
Tel. : + 33 (0) 5 55 06 87 87
Fax: + 33 (0) 5 55 06 74 55